



°eluma Technical Manual

LED Shelving, DecoPanel & DecoSplash

°eluma Shelving General Specifications 3

EL001 Profile4

EL002 Profile5

°eluma Shelving Insert Specifications 6

°eluma Shelving Component Specifications7

°eluma Shelving Installation Instructions 9

°eluma DecoPanel & DecoSplash General Specifications 10

EL003 Profile 11

°eluma DecoPanel & DecoSplash Insert Specifications 12

°eluma DecoPanel & DecoSplash Construction Specifications 13

LED Specifications 14

Transformer Specifications 15

°eluma Wiring Components 16

On-Off Switch 17

Warranty 18

- Custom Sizes - panels manufactured in 1/16" increments
- Short lead time
- Adjustability - plug and play magnet to power bar allows adjustment after installation without wiring
- LED technology - long life span (50K hours at 11.7 years @ 12 hours per day), extremely low power (12VDC), minimal heat (versus fluorescent or halogen light shelves)
- Easy system to incorporate into cabinet or display program, as a standard product or as an upgrade
- Versatility - can be used as panels, doors, shelving, etc. - unlimited design possibilities
- Durability of 1/4" tempered safety glass or abrasion resistant acrylic
- Fully Assembled - arrives built and ready to wire (this product cannot be disassembled)
- ETL listed system for the US & Canada
- Panel sizes up to 111" - Consult Element Designs for lengths exceeding 111"
- LEDs installed on one side - typically width rail
- Frames are available in 2 profiles and 5 finishes
- Inserts are 1/4" tempered safety glass with proprietary etching technology or light transmitting acrylic
- Three LED color temperatures K (Kelvin):
 - 1) Warm (3500K)
 - 2) Daylight (6500K)
 - 3) RGB (Color Changing)
- Thermally regulated by aluminum frame system
- 0.3W per LED & LED amperage regulated by in-circuit resistors

* Both ETL and UL are privately owned, Nationally Recognized Testing Laboratories (NRTL) as recognized by OSHA and local inspectors. UL is the largest in the US, while ETL is largest worldwide. No mark is better than the other, each serving as proof of product compliance to US and Canadian standards.

EL001

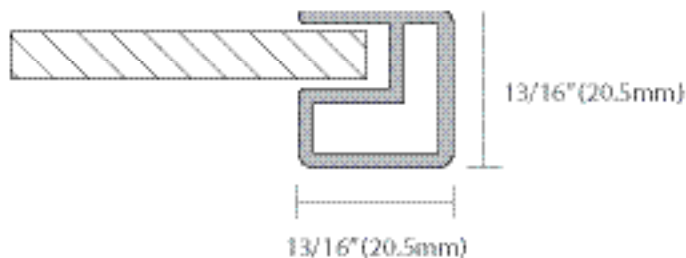

Profile Finishes

_____ Anodized Aluminum _____



natural aluminum



brushed stainless

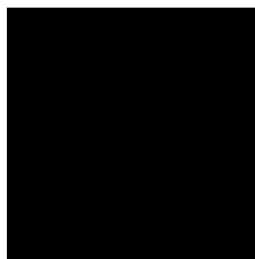

black

_____ Powder Coat _____

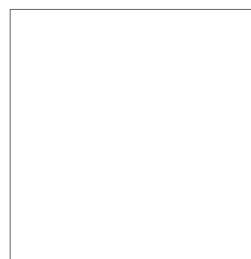

white

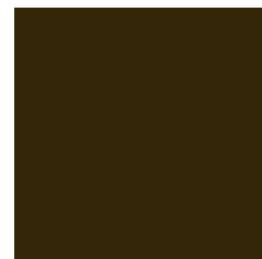

oil rubbed bronze

Design Guidelines:

- Minimum width / length = 5" (127 mm)
- Maximum width / length = 111" (2819.4 mm)
- 1/16" lines maximum standard depth = 18" (457.2 mm)
- 1/4" lines maximum standard depth = 15" (381mm)
- Maximum oversized depth / height = 36" (914.4 mm) with 1/16" lines or 30" (762 mm) with 1/4" lines (LEDs located along two sides)
- 1/4" tempered safety glass has a weight bearing capacity of approximately 75 lbs per square foot
- eluma shelves can be mounted with standard shelf support methods
- **Intermediate shelf supports recommended for shelves over 30"**

EL002

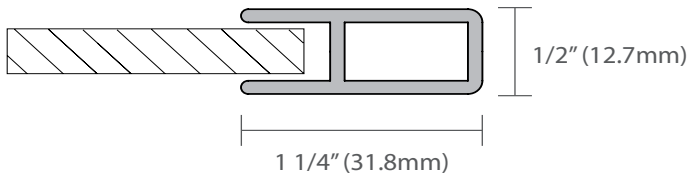

Profile Finishes

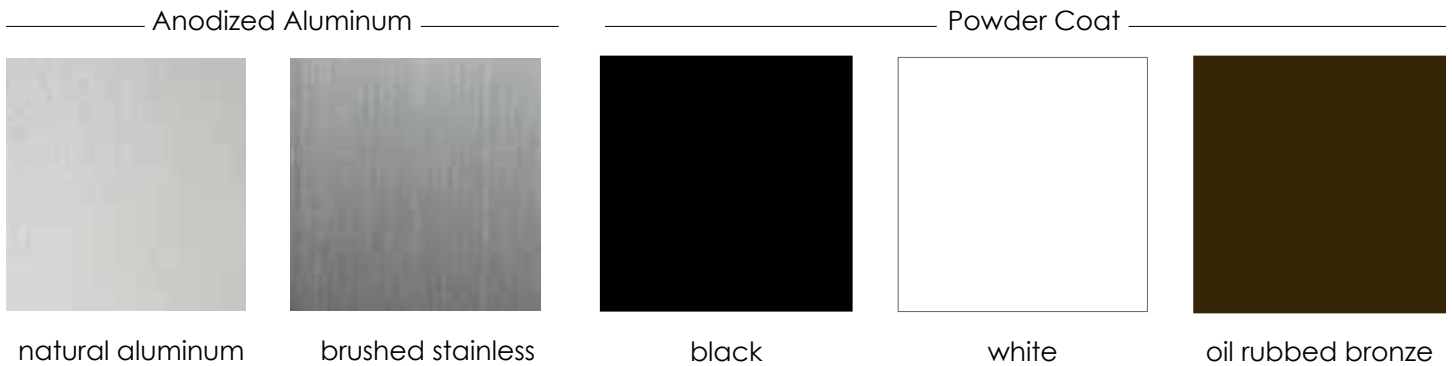

Design Guidelines:

- Minimum width / length = 5" (127 mm)
- Maximum width / length = 111" (2819.4 mm)
- 1/16" lines maximum standard depth = 18" (457.2 mm)
- 1/4" lines maximum standard depth = 15" (381mm)
- Maximum oversized depth / height = 36" (914.4 mm) with 1/16" lines or 30" (762 mm) with 1/4" lines (LEDs located along two sides)
- 1/4" tempered safety glass has a weight bearing capacity of approximately 75 lbs per square foot
- Element Designs offers cable mounting shelf systems for shelves up to 16" deep (ONLY available for EL002)
- °eluma shelves can be mounted with standard shelf support methods
- **Intermediate shelf supports recommended for shelves over 30"**

1/4" Tempered Safety Glass

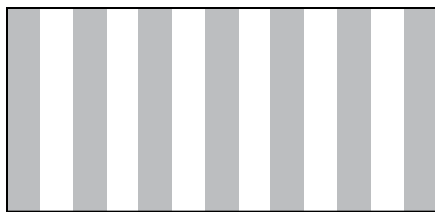

1/4" illuminated etched lines at 1/4" spacing



1/16" illuminated etched lines at 1/4" spacing



Linear Etch Pattern

**glass may contain minor imperfections which are inherent to the manufacturing process*

- 1/4" tempered safety glass is used in eluma panels
- The load bearing capability is 75lbs per square foot.
- The glass used in eluma is a proprietary process and product that gives eluma its' illumination characteristics.
- The etched lines are recommended to be in the same direction that the light (parallel to depth) is traveling.
- The etched lines are required - they are what carries the light throughout the panel. The lines are available in two thicknesses: 1/16" & 1/4". The spacing of the lines is 1/4" for both line thickness options.
- 15" depth/height glass is recommended for one strip of LEDs. There is a 50% drop-off of light at 15" depth/height.
- The amount of etching affects the light output. Thin lines provide higher light output than thick lines for longer depth panels. The light drop-off is still 50% at 15", however, the thin etched lines are brighter.
- Shelving (horizontal) applications at or around eye level will help to hide the light drop off condition.
- When panel depth/height must be greater than the recommended maximum of 15", opposing LED strips may be used.
- Customer etched logos in the glass are possible based on the customer supplying the image in the following format:
 - Black & White (only) OR line drawings
 - Bitmap file type preferred but JPEG is also possible
- High resolution image (>500KB)
- A custom logo etching fee will apply. The chemically etched logo fee is economical versus other glass etching techniques.
- Small scratches, bubbles, etc. may be visible in the insert when eluma is turned on. These are inherent within the glass and are part of the product.

Technical specifications are subject to change.

Adjustable Panel Components

Power Bar (EL-MAG-TR-1M)

The power bar track is designed to be installed vertically (primarily) or horizontally in a box or on a wall. The bar is 1M (39") in length and comes with two end caps that are NOT pre-installed.

- Both power bar end caps, white male connector, and screws are bagged separately.
- One end cap includes a power feed with a 12" wire that will be fitted with the male white connector. The other end cap is for mounting purposes only.
- The white male connector will not be installed so that the installer can route the wire through a thru hole and keep the hole diameter minimized. The wires should be checked for correct orientation to the connector block on the transformer (note the side with the clip is the positive side of the block). Once correct orientation is achieved, the wires should be firmly pushed into the white male connector.
- The track is cut using any type of saw.
- The track can also be linked to other tracks using additional track link components. (Not supplied as a standard component. Contact Element Designs for more information.)

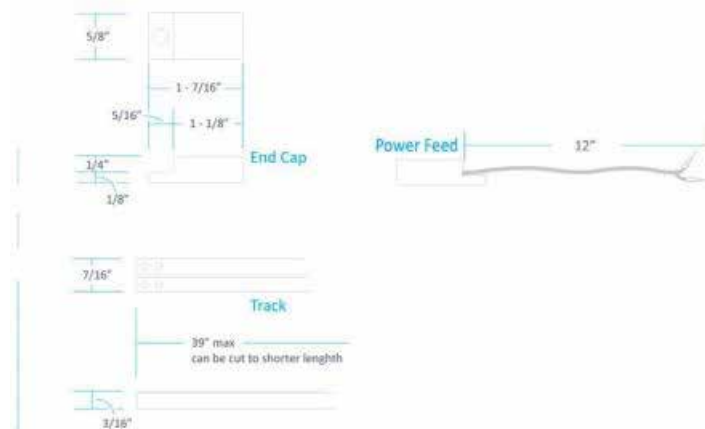

Magnet (EL-MAG-ADP)

Magnet adapter that clips to power bar. The magnet has a black male connector that will plug directly into the 2" (approx.) pig tail that exits the °eluma panel.

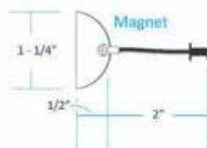

Extension wire for power bar (EL-EXT-2M)

2M (78 3/4") extension wire to plug wire coming from power bar to transformer. Note if transformer & power bar are in close proximity, this extension wire is not necessary.

Fixed Panel Components

Extension wire from panel (EL-EXT-PKT-2M)

2m (78 ¾") extension wire that has male connector to plug directly into panel. To be used when adjustability feature is not necessary.



Extension wire for power bar (EL-EXT-2M)

2M (78 ¾") extension wire is same as above but used in this application for additional extension between PKT 2M extension wire & transformer.

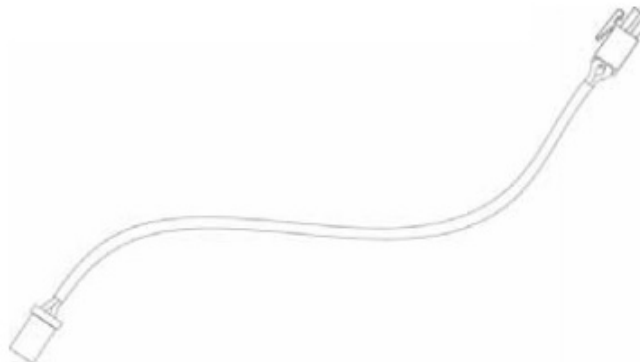

eluma Panel with Power Bar

****Read and follow all safety and installation instructions carefully****

Before beginning any wiring, be sure power is turned OFF to transformer.

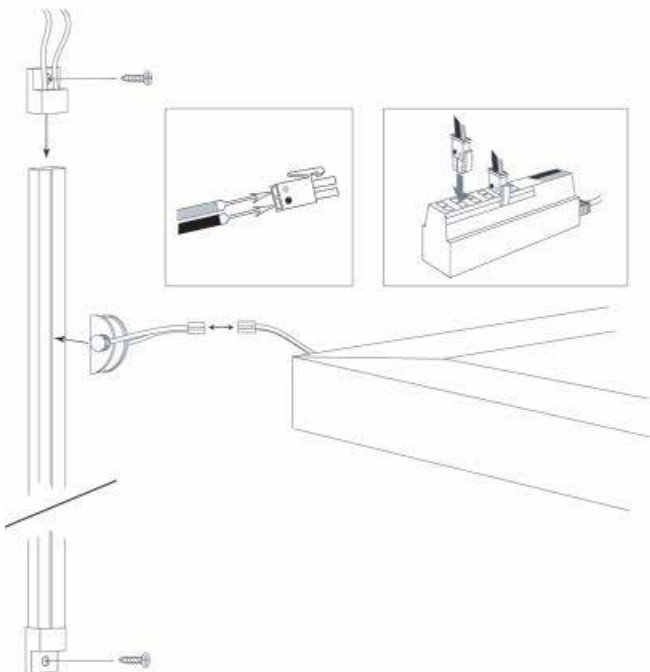

IMPORTANT SAFETY INSTRUCTIONS

CAUTION: To reduce the risk of fire, electric shock, exposure to excessive UV radiation, or injury to persons:

- Use only in dry indoor locations. Not for use where exposed to the weather.
- Power bar cannot touch any other conductive surface (metal, etc.) or an electrical short may occur.
- Wiring and materials should conform to national (NEC) and local electrical codes.
- A licensed electrician should be consulted for wiring through ceilings, soffits or walls.
- Shelves over 36" should use an additional center shelf support.
- Do not exceed 75 lbs per shelf (including shelf weight = 3lbs/ sq.ft).

To Install Magnetic Power Bar:

1. Determine where to install 12V DC power supply (EL-DC-ELT60-CON or EL-DC-ELT18-CON) and power bar. Be sure power bar wires will properly reach the transformer and 120V power source.
2. Position and mount 12V DC transformer (EL-DCELT60-CON or EL-DC-ELT18-CON).
3. Magnetic Power Bar is available in standard 1M (39") track lengths. Cut track lengths as required. Precaution: When cutting track, hold it firm to prevent the metal track rails and nonconductive barrier (black plastic) from pulling apart. For best results, clamp track to a vise and cut slowly.

To Wire Power Bar:

4. Slide power feed over bar (pressure fit).
5. Position power bar. Use mounting end clips with screws to mount power bar to surface. (Recommended track locations: on inside face frame of cabinet, or right side of back wall of cabinet in frameless cabinets.)
6. Run wire to transformer. Snap wire into transformer block. Caution: Transformer must be turned off when making connections. 60W max per transformer. Be sure to keep polarity correct: (+)Red with (+)Red, (-)Black with (-)Black.
7. Place panel in cabinet onto shelf pins that meet KCMA requirements. Wire should be facing power bar.

To Install Panels (Shelves):

8. Connect panel wire to magnet and place magnet on power bar. Be sure to keep polarity correct: (+)Red with (+)Red, (-)Black with (-)Black. If shelf does not light, reverse the magnet connection to re-establish polarity.
9. Double check all connections and then turn power on to transformer

Save these instructions for future reference. For technical assistance: (704) 332-3114

ATTENTION: Altering system from manufacturer's instructions/recommendations voids all warranty
Technical specifications are subject to change.



- Custom manufactured to exact specifications to 1/16"
- Energy efficient LED technology with 50,000 hours useful life (11.5 years when used 12 hours per day)
- Available with warm (3500K), daylight (6500K) LEDs or RGB LEDs
- Endless decorative insert panel options including architectural resins, digitally printed glass and patterned glass
- Glass can be custom digitally printed with any high resolution image
- Frames are available in several finishes including natural aluminum, brushed stainless steel, black, white and oil rubbed bronze powder coat
- Three to four week lead time
- No minimum order quantity
- Made in the USA

Both ETL and UL are privately owned, Nationally Recognized Testing Laboratories (NRTL) as recognized by OSHA and local inspectors. UL is the largest in the US, while ETL is the largest worldwide. No mark is better than the other, each serving a proof of product compliance to US and Canadian standards.

EL003

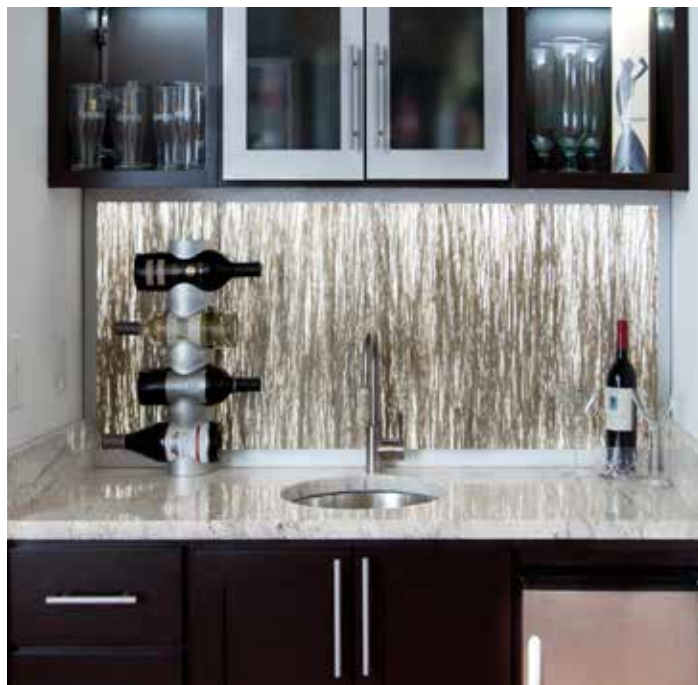
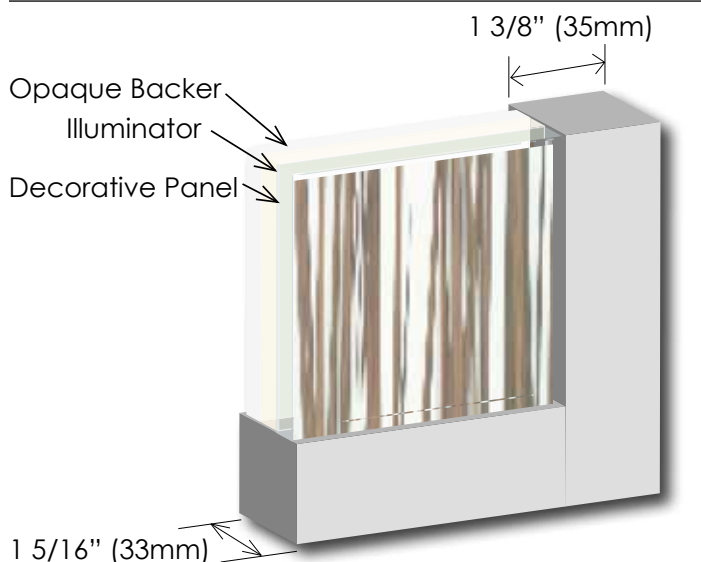

Profile Finishes

_____ Anodized Aluminum _____



natural aluminum



brushed stainless

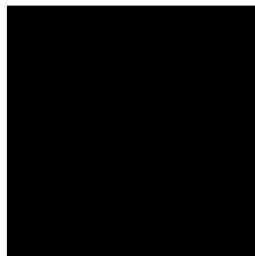

black

_____ Powder Coat _____

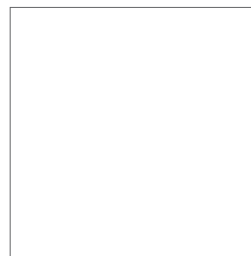

white



oil rubbed bronze

Design Guidelines:

- Minimum height = 5" (127 mm)
- Maximum height = 96" (2438.4 mm) or 118" (2997.2mm) based on decorative insert
- Minimum width = 5" (127mm)
- Maximum width = 36" (914.4mm)
- All maximum dimensions are based on decorative insert size. Contact Element Designs for more information or if requested size exceeds maximums.

Technical specifications are subject to change.

3form Architectural Resin Insert Options



bear grass



fossil leaf



silver wisp



thatch



ting ting

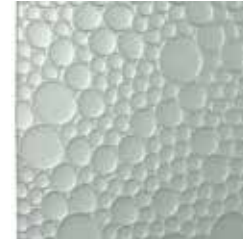

pop clear

Textured Glass (Tempered)



low-iron satin



satin



austral



master carre



reeded

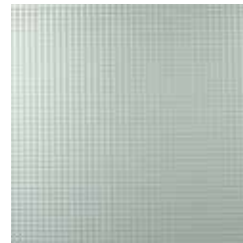

listral D

Contact Element Designs for custom images or digitally printed glass options

Technical specifications are subject to change.

DecoPanel

Wire Exit Location

Wire exit location can be located in any corner and must be specified at the time of order.

Wire Exit Length

Standard exit wire length is 3". Additional length may be added by including extension wire hardware.

Standard LED placement for DecoSplash is along the top of the backsplash. Backsplashes over 18" in height will require opposing LED strips.

Maximum wire length if wire exit is opposite of LED strip placement = 120" - width of panel

Screw Placement

Screw placement is necessary for double sided DecoPanel only where both front and back of frame will be visible.

Single sided DecoPanel utilizes internal bracket construction with screws on back of panel.

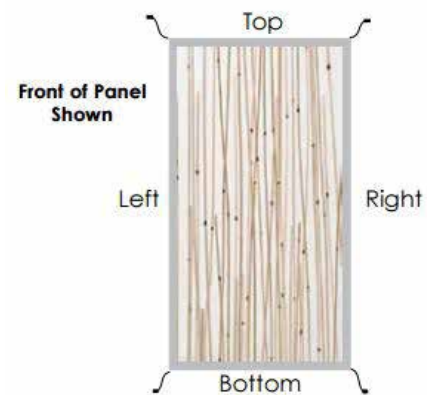
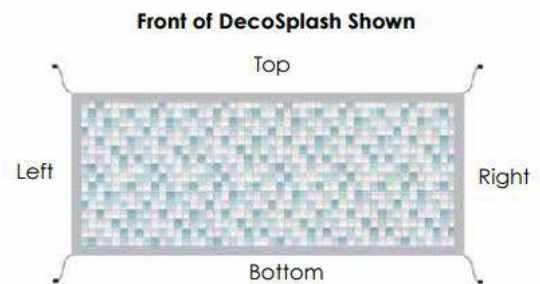
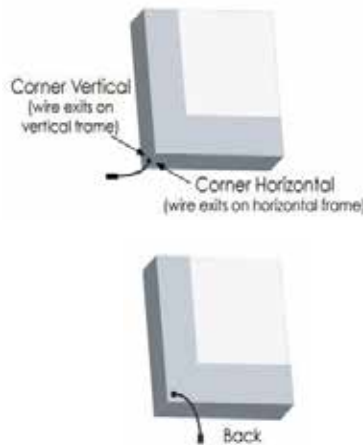

DecoSplash

Wire Exit Location

Wire exit location can be located in any corner and must be specified at the time of order.

Wire Exit Length

Standard exit wire length is 3". Additional length may be added by including extension wire hardware.

Standard LED placement for DecoSplash is along the top of the backsplash. Backsplashes over 18" in height will require opposing LED strips.

Maximum wire length if wire exit is opposite of LED strip placement = 120" - width of panel

Technical specifications are subject to change.

LED Color Options

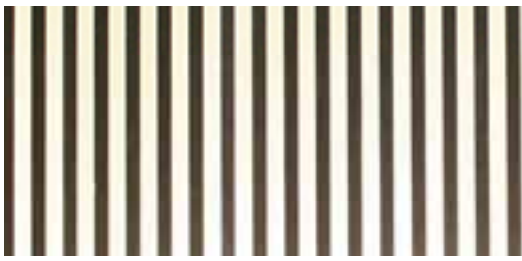

warm (3500K)

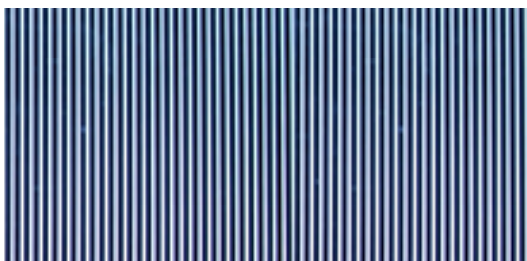

daylight (6500K)

- High quality LEDs from one of the world's leading manufacturers
- 50,000 hr useful life (under ideal conditions as is with all LED ratings) = 11.7 years @ 12 hours per day
- The LEDs for eluma are offered in two colors: warm & daylight
- Warm has a soft yellowish glow and is commonly used in residential applications. The color temperature is 3500K.
- Daylight has a cool bluish tint and is commonly used in commercial & retail applications. The color is 6500K.
- .3W per LED
- LEDs spaced @ 30mm
- 1LF of light output is 3W
- 3-chip diode units
- 120° of light dispersion from LEDs
- 12VDC input power
- CRI (color rendering index) of 90(out of 100).
- Colored LED panels are also available in a variety of colors.

RGB Color Changing LED

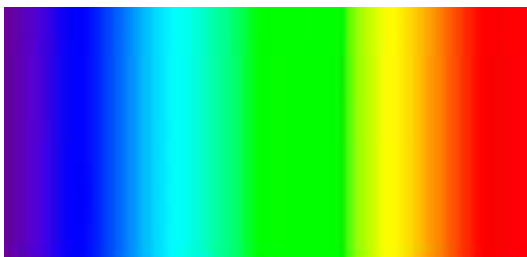

RGB (color changing LED)

Includes programmable RF remote with color, speed and dimming control

- Wireless RF Controller powers units on/off. Controller selects many static color modes with color ring and contains 15 dynamic color changing modes with speed and brightness controls. KeyMatch technology allows the RF remote to be matched to only one controller or multiple controllers to drive several sections of RGB lights.

- 3 watts from the transformer will support approximately 1LF of LED light output
- The 60W transformer has a connector block with six possible inputs (6 panels)
- Maximum distance from transformer to panel or power bar track is 12ft. based on two 2M extension wires
- The short-circuit transformer is protected by automatic reset (no fuses)
- Transformers are overheat/overload protected with automatic reset (no fuses)
- FCC rated - the transformers will not interfere with other electronics
- 60W (EL-DC-ELT-60-CON): 60W maximum transformer (20LF of LEDs)
- The 60W transformer is ideal when powering multiple panels
- The input voltage is 100-240V @ 1.5A with an output of 12V-5A

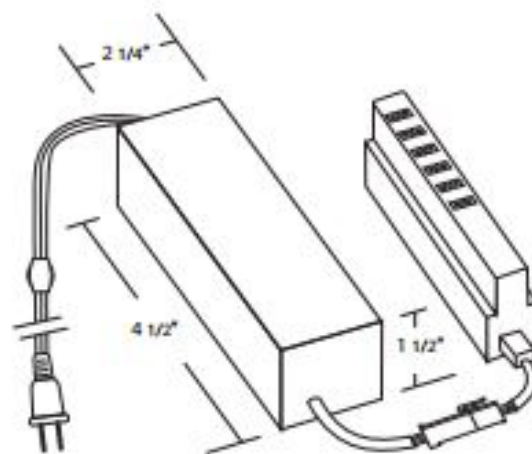

EL-DC-ELT-60-CON

- **60W (EL-DC-ELT-60-CON):** 60W maximum transformer (20LF of LEDs)
- The 60W transformer is ideal when powering multiple panels
- The input voltage is 100-240V @ 1.5A with an output of 12V-5A

Extension wire from panel (EXT-PKT-2m)

2M (78 3/4") extension wire with male connector. Connects panel to connector block/transformer. **(1 REQUIRED PER PANEL)**



Extension wire (EXT-2m)

2M (78 3/4") extension wire when additional length is needed between panel and transformer. **(OPTIONAL)**

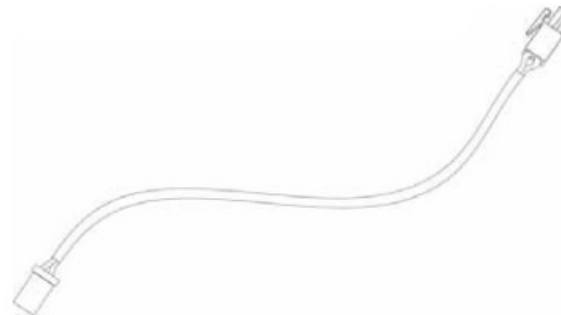

Remote Control Dimmer (LED-DIMRMT-12V)

12V remote control dimmer

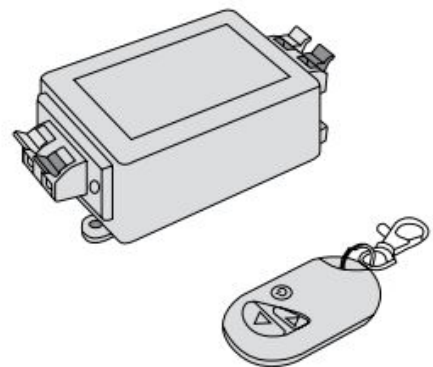

On-Off Switch EL-RDSW-M-WH (white) & EL-RDSW-M-BL (black)

Simple on-off rocker switch that can control one or multiple panels on the same transformer.

For one panel, plug the panel extension wire directly into the rocker switch. The other end of the rocker switch will plug into one terminal on the six input terminal block.

For multiple panels, plug the rocker switch in between the transformer itself & the six connector terminal block. The switch will control up to six panels simultaneously on the terminal block.

The rocker switch should always be installed on the 12 VDC side of the eluma system.



****Read and follow all safety and installation instructions carefully****

A. To Control All Lights with One Transformer

1. Determine location of switch
2. To recess mount switch: Drill 13/16" hole for switch. Place wires through hole and push switch completely unto hole until snug.
3. Plug female end of switch into wiring block. Plug male end of switch into female end of transformer (12V side).

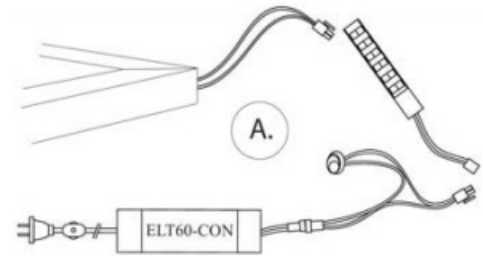

B. Control Lights Independently

1. Determine location of switch
2. To recess mount switch: Drill 13/16" hole for switch. Place wires through hole and push switch completely unto hole until snug.
3. Plug male end of switch into wiring block. Plug light into female end of switch.

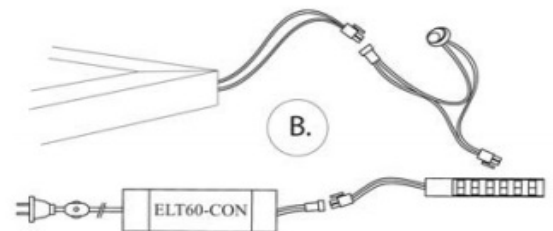

Warranty

- The eluma system carries a one year warranty from date of manufacture that will cover parts and labor.
- Any altering of the system will void warranty.

Repair/Replacement Program

- Element Designs will offer a repair and replacement program for panels which are not covered by warranty.
- The customer is not permitted to disassemble or alter the product in any way.
- All repairs must be performed by Element Designs.
- A fee of \$50.00 will apply to all repairs - not including any components.